

Calculation analysis of bulldozer's productivity in gravitational transport on open pits

Klanfar, Mario; Kujundžić, Trpimir; Vrkljan, Darko

Source / Izvornik: **Tehnički vjesnik, 2014, 21, 517 - 523**

Journal article, Published version

Rad u časopisu, Objavljena verzija rada (izdavačev PDF)

Permanent link / Trajna poveznica: <https://um.nsk.hr/um:nbn:hr:169:980801>

Rights / Prava: [Attribution 4.0 International](#)/[Imenovanje 4.0 međunarodna](#)

Download date / Datum preuzimanja: **2024-07-24**



Repository / Repozitorij:

[Faculty of Mining, Geology and Petroleum
Engineering Repository, University of Zagreb](#)



CALCULATION ANALYSIS OF BULLDOZER'S PRODUCTIVITY IN GRAVITATIONAL TRANSPORT ON OPEN PITS

Mario Klanfar, Trpimir Kujundžić, Darko Vrkljan

Original scientific paper

Analysis of accuracy and calculation applicability of bulldozer's productivity in gravitational transport on open pits has been conducted by comparing computational values obtained by theoretical formulas and results of field measuring. The magnitude of the volume of blade load and the speed of bulldozer's motion, which are the main factors for assessment of machine productivity, have been measured and compared at the same length of transport. Significant deviation of computational specified bulldozer's productivity has been noticed with regard to the ones measured in real conditions. Calculation improvements have been suggested in order to better approximate real exploitation effects by introducing new formulas for the volume of blade load and the speed of bulldozer's motion. The curvature of bulldozer's blade has a substantial effect on the volume of pile in front of blade, and it is not negligible in the calculation. By comparing computational values of different authors, deviations between 3 % and 40 % from measured values have been obtained. The new proposed formula with a 3 % deviation has been proved to be the most accurate. Theoretically calculated maximum speed of bulldozer's motion by means of engine power significantly deviates from the actual measured speed (>49 %). The speed of bulldozer's motion according to the rimpull diagram and the adjusted formula that represents a universal rimpull characteristic of the bulldozer, is applicable in transport where the influence of blade load pushing resistance is prevalent to the bulldozer's speed (deviation <16 %). Bulldozer's speed of motion backwards is more reliable to determine by experience because deviation of computational value (>160 %) introduces a significant error in the productivity assessment.

Keywords: bulldozer, exploitation of mineral raw materials, gravitational transport, machines' productivity, mining

Analiza proračuna učinka dozera pri gravitacijskom transportu na površinskim kopovima

Izvorni znanstveni članak

Analiza točnosti i primjenjivosti proračuna učinka dozera, pri gravitacijskom transportu otkrивke na površinskom kopu, provedena je usporedbom računskih vrijednosti dobivenih prema teoretskim obrascima i rezultatima terenskih mjerenja. Mjerene su i usporedene vrijednosti obujma vučne prizme i brzine kretanja dozera, koji su osnovni faktori za određivanje učinka stroja, u uvjetima iste duljine transporta. Uočena su znatna odstupanja računski određenih učinaka dozera u odnosu na izmjerene u stvarnim uvjetima. Predložena su poboljšanja proračuna u cilju približavanja stvarnim eksploatacijskim učincima uvođenjem novih obrazaca za obujam vučne prizme i brzinu kretanja dozera. Zakrivljenost noža dozera ima znatan utjecaj na obujam vučne prizme i nije zanemariva u proračunu. Usporedbom računskih vrijednosti po različitim autorima dobivena su odstupanja između 3 % i 40 % od mjerenih vrijednosti. Najtočnijom se pokazala novopredložena formula s odstupanjem od 3 %. Teoretski proračunata maksimalna brzina kretanja dozera prema snazi stroja, značajno odstupa od stvarne izmjerene brzine (>49 %). Brzina kretanja dozera prema vučnom dijagramu, te prilagođenoj formuli koja predstavlja univerzalnu vučnu karakteristiku dozera, primjenjiva je u slučaju transporta gdje prevladava utjecaj otpora vučne prizme na brzinu dozera (odstupanje <16 %). Brzinu kretanja dozera unatrag pouzdanije je odrediti iskustveno, jer odstupanje računске vrijednosti (>160 %) uvodi značajnu pogrešku u procjenu učinka.

Ključne riječi: dozer, eksploatacija mineralnih sirovina, gravitacijski transport, rudarstvo, učinak strojeva

1 Introduction

Throwing of overburden and mineral raw material from working to transportation benches makes a technological phase that cannot be omitted in some systems of mineral raw material exploitation. Gravitational transport, as the most economical way of transport, is customary on most quarries of crushed stone in the Republic of Croatia. Bulldozer is one of the often used machines for throwing of materials. The existent productivity calculation of this machine is regularly related to a certain dozing technique, that is, excavation, transport, disposing and planning. Based on this kind of work mode, various authors suggest formulas and calculation parameters for the calculation of the bulldozer's productivity.

Throwing of mineral raw material characterizes a somewhat different dozing technique, as well as the bulldozer's work conditions. Main differences in relation to typical dozing technique are: side blade filling of material, absence of excavation or cutting due to the loose state of the material, absence of disposing of the material. In other words, transport is taking place to the crest of the bench, and then the material lowers gravitationally, and also, a short trajectory of the bulldozer (limited by the

width of bench berm) makes the material loss negligible during transport.

Recent research in this area includes laboratory testing and numerical modelling of mechanical interaction of bulldozer's blade and materials. Most models deal with determining the relation of rimpull force with material characteristics, geometry of blade and depth of cutting [1 ÷ 4]. Other models have wider possibilities, where the rimpull force, volume of material and loss of material along the whole bulldozer's trajectory is predicted with defining the blade's incline in three axes, terrain incline and material characteristics [5]. Numerical models mostly show good correlation with the testing on diminished laboratory models. However, complex formulas and greater number of required parameters do not make them easy for practical use.

The aim of research in this paper is the analysis of the analytical bulldozer's productivity calculations' accuracy and applicability in gravitational transport, for the purpose of a simpler and more practical procedure of productivity estimation. Calculations are based on existent formulas of various authors for determining the volume of blade load and bulldozer's speed motion, as the main factors that determine the productivity. Also, two new formulas have been suggested, with the goal of increasing calculation accuracy. The results are compared with the values

obtained by field measurement on a real case of gravitational transport of overburden.

2 Calculation of bulldozer's productivity

Calculation of bulldozer's productivity can be broken down to three main segments: determining the volume of blade load, determining the speed of motion (duration of the cycle), and finally, determining the productivity along with the application of correctional coefficients for working conditions and utilization of working hours. Certain calculations include calculation of speed of motion on the basis of previously determined required bulldozer's rimpull.

2.1 Volume of blade load

Volume of blade load is generally calculated by simplifying its geometric figure by prism or parallelepiped. Its dimensions depend on the height and width of bulldozer's blade and angle of repose of the material, which is multiplied by coefficients that take into consideration the type and characteristics of the material.

According to Slunjski [6], volume can be approximately determined by a formula (1) for the volume of three-sided prism, which as a base has a right-angle triangle with two sides equal to the height of the blade h , and the height equal to the width of the blade. The formula does not take into consideration the characteristics of the material.

$$V = \frac{l \cdot h^2}{2} \tag{1}$$

A similar formula (2) is used with introducing the coefficient of blade filling k_p which introduces the properties of the material and amounts to 1,05 ÷ 1,45 for cohesive soil and 0,65 ÷ 0,9 for cohesionless soil [7, 8]. In this paper's calculations, k_p is estimated ranging from 0,8 ÷ 0,9 because of the loose material.

$$V = \frac{l \cdot h^2}{2} \cdot k_p \tag{2}$$

Formula (3) is also based on the volume of the prism. However, the length of the lower base side is calculated from the height of the blade and angle of repose of the material φ [9]. Angle of repose of rock mass is determined during field measuring and amounts to 38° ÷ 40°. This span of angle of repose has been used in all succeeding formulas which apply to that parameter.

$$V = \frac{l \cdot h^2}{2 \cdot \tan \varphi} \tag{3}$$

The next formula (4) in addition to the angle of repose introduces a correctional coefficient k that takes into account the fragment size and cohesion of material, and amounts to 0,8 for sand, gravel and fragmented rock, and to 1,0 for soil [10]. In this calculation, correctional coefficient has been estimated to range from 0,8 ÷ 0,9,

since its application is meant for a well fragmented rock with very little soil.

$$V = \frac{l \cdot h^2}{2 \cdot \tan \varphi} \cdot k \tag{4}$$

According to Linarić [11], the volume of dragging prism is calculated by multiplying the volume of parallelepiped with coefficient of blade k_n , which describes the hardness of excavation and type of material by particle size, moisture and cohesion, and it ranges from 0,4 for very hard excavation of rocks to 1,0 and higher for easy excavation of dry loose ground. In this case, spoil material is a loose incoherent material and it represents an easy excavation. However, it contains blocks of bigger dimensions and it is visibly humid. Therefore, coefficient of blade is estimated to range from 0,8 ÷ 0,9.

$$V = l \cdot h^2 \cdot k_n \tag{5}$$

The aforementioned formulas disregard the vertical curvature of bulldozer's blade and the tendency of dragging prism to form a mild parabolic shape at the top. Therefore, the authors suggest a new formula based on the angle of repose of rock mass φ and blade curvature c , which is defined by the height of the circular segment in the centre of the blade (6). The formula is basically equal to the formula (3) with the addition of volume inside the blade (Fig. 1), which is specified by a geometric analysis for blades of typical radius of curvature ranging between 0,5 and 2 m.

$$V = l \cdot \left(\frac{h^2}{2 \tan \varphi} + 0,698 \cdot h \cdot c \right) \tag{6}$$

According to the standard SAE J1265, formulas for calculation of capacity of the straight S-blade and the universal U-blade are defined. Primary purpose of these formulas is not to determine the actual bulldozer's productivity, but to define the unique method for determining the volume of dragging prism of blades so as to compare them relatively.

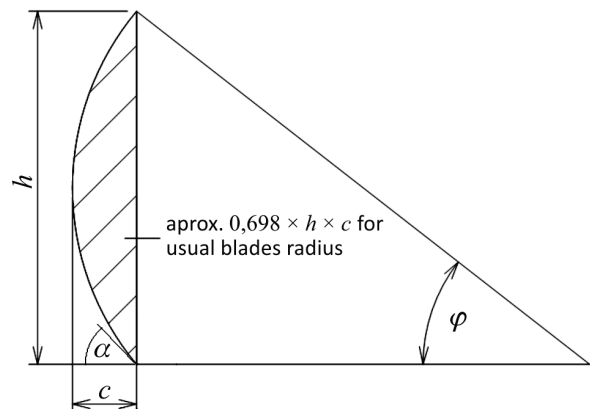

Figure 1 Influence of blade's curvature on load volume

Their specificity is to determine the volume of dragging prism of bulldozers through the effective height

of blade and the horizontal geometry (curvature) of U-blade types. In this case the volume of dragging prism is calculated by the formula (7) since the blade is straight. The effective height (8) takes into account the influence of the blade stricture at the top, and it represents a ratio of the blade's area projected on the vertical plane and its width. The projected area of respective blade A_m determined by measuring amounts to 6,16 m².

$$V = 0,8 \cdot l \cdot h_{\text{ef}}^2, \quad (7)$$

$$h_{\text{ef}} = \frac{A_m}{l}. \quad (8)$$

In the original form, some of the mentioned formulas use the bulk factor for the excavation of materials in intergrown state and the coefficient of loss of material during transport. Rock mass is in loose state during bulldozing, while the loss of material is compensated by a narrow side cut during transport, so the before mentioned two factors are not included in the calculation.

2.2 Rimpull and bulldozer's velocity

The necessary rimpull depends on the total resistance to bulldozer's motion which can be broken down to four main parts: excavation resistance or cutting resistance of material, rolling resistance, resistance to pushing of dragging prism, and grade resistance [13]. During throwing, a bulldozer works on a horizontal terrain so the grade resistance is non-existent. Material is in loose state so there is no cutting resistance, although in case of greater height of blasted or lay down mass, and consequently greater compaction, there could appear an additional resistance of the blade's side cut, that is, separation from the mass. A significant difference was not noticed between measured speed of loading the blade and the speed of the bulldozer during transport, so it was concluded that there is no greater resistance during side cut and consequently that it is not necessary to count on cutting resistance.

Total resistance W is calculated by a formula (9) which includes two parts; rolling resistance and resistance to pushing the dragging prism. Rolling resistance on the ground depends on the weight of machine G_n and the specific rolling resistance w_k for machines on crawlers [13]. w_k is estimated to range from 0,03 ÷ 0,04 kN/kN, considering the hard ground with a loose surface layer. Resistance to pushing dragging prism is calculated on the basis of the average measured volume V that amounts to 9,77 m³ and the specific weight of spoil material γ ranging from 16 ÷ 17 kN/m³. Friction coefficient of prism on the ground μ is estimated on the basis of angle of repose, and is increased due to the humidity and compaction of material during transport; it amounts to 1,1 ÷ 1,2. Friction coefficient of the material on the blade's surface μ_1 is assumed to be ranging from 0,4 ÷ 0,5, which amounts to the friction coefficient of rocks on steel, increased because of humidity and compaction of material on bulldozer's blade. The cutting angle α (Fig. 1) of bulldozer's blade is determined by measuring and

amounts to 45°. Rimpull necessary for backwards return depends only on the rolling resistance on the ground and is calculated by using the first member of the equation (9).

$$W = G_n \cdot w_k + \gamma \cdot V \cdot (\mu + \mu_1 \cdot \cos^2 \alpha). \quad (9)$$

The speed of bulldozer's motion is possible to determine by calculation. However, the results are questionable because they depend on parameters that are difficult to measure: adhesion between the ground and crawlers, the necessary dragging force, the available rimpull and tractive force, operator's skill and other working conditions. As rule of thumb, the speed of cutting and transport amounts to 0,8 ÷ 1,4 m/s, and the speed without the load 1,4 ÷ 1,9 m/s [14], but those are rough values which can significantly differ depending on actual conditions.

The speed of bulldozer's motion forwards and backwards is determined in three ways, according to the corresponding calculated rimpull. The theoretical maximum speed is calculated through power of the driving engine P (Eq. (10)), where the efficiency coefficient of driving engine η takes into account the power dissipation of engine and transmission system, and the value ranges from 0,8 ÷ 0,9 [13]. The other method is to read from the rimpull diagram of the manufacturer for the specific bulldozer (Fig. 2).

$$v = \frac{P \cdot \eta}{W}. \quad (10)$$

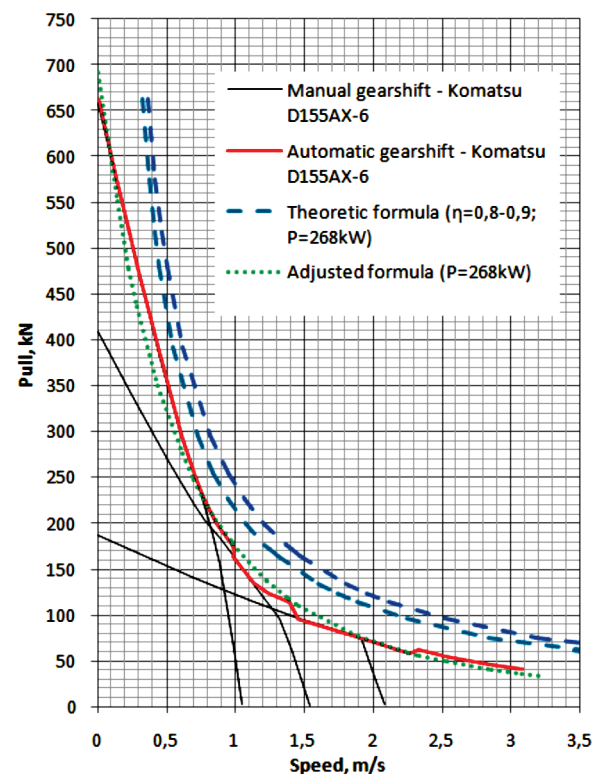

Figure 2 Rimpull diagram

Rimpull diagrams give a realistic ratio of rimpull force and speed, which is established by the manufacturer. However, they apply only for the specific bulldozer.

A new formula (11) has been created by digitalization and statistical analysis of rimpull diagrams of bulldozer's with various power, between 79 and 671 kW, [14, 15]. The formula follows a general form of rimpull diagram, and the ratio of rimpull and speed relates to the power of driving engine, which represents a universal rimpull characteristic of bulldozers.

Fig. 2 represents the comparison of both formulas and the rimpull diagram for the bulldozer used here.

$$v = \frac{24,3}{\ln\left(\frac{260 \cdot W}{P}\right)} - 3,71. \tag{11}$$

2.3 Duration and productivity of bulldozer's cycle

Duration of bulldozer's cycle with the volume of dragging prism is the basis for further calculation of machine's technical productivity. Depending on the operating cycle of bulldozer, the durations of certain phases (excavation, transport, disposing and returns) are added up on the basis of determined speed and corresponding trajectory lengths.

When throwing overburden with a bulldozer, the disposing phase is omitted because of the gravitational lowering of material to a subjacent bench. Measuring speed of motion during blade filling and transport did not show significant distinctions. Therefore, the bulldozer's cycle during throwing is determined by including the speed of forward motion v_t and backward motion v_o by a trajectory of the same length l_c (12). The parameter t_m represents the time of speed change, in other words, the direction for which most authors claim the value of $3 \div 6$ s, while the measured value amounts to $3 \div 4$ s.

Technical bulldozer's productivity can then be determined by the formula (13). The exploitation productivity of bulldozer's which includes delay because of transferring, servicing and other reasons was not considered. The listed influences were not measured, and they can also significantly differ from case to case.

$$T_c = l_c \cdot \left(\frac{1}{v_t} + \frac{1}{v_o} \right) + 2t_m, \tag{12}$$

$$Q_c = \frac{3600 \cdot V}{T_c}. \tag{13}$$

3 In situ verification of computational volume of blade load and bulldozer's velocity

Measuring of bulldozer's productivity was conducted in actual conditions during gravitational transport of overburden on a quarry Žervanjska near Orahovica. *Komatsu D155AX-6* bulldozer was used. Its main characteristics are shown in Tab.1. Bulldozer's operating cycle consists of a side blade filling of the material and transport to the edge of the bench, and then of a backwards return of the same trajectory. The trajectory is $24 \div 25$ m long. Around the first third of the trajectory the

more intense blade filling takes place, that is, the formation of dragging prism with a somewhat wider side cut. After the formation of blade load, the material is transported with a narrow side cut in order to eliminate the loss of material during transport. The full volume of blade load gravitationally lowers on underlying bench as bulldozer approaches the edge of the operating bench (Fig. 3).

Rock mass transported during measuring is overburden or a spoil cover of mineral resource that is composed of clastic rock of different fragment sizes. Overburden has previously been mechanically excavated and reposed on the berm. Clastic rocks have unfavourable mechanical properties, their fragment size ranging from a few millimetres to approximately 30 cm, with the smaller portion of large blocks measuring from 30 to 90 cm. The rock is mixed with very little earthen and clay particles, without visible stickiness. Ground condition for bulldozer's operation is generally firm, along with a thin surface layer of loose material, especially towards the edge of the bench where it is accumulating because of material loss in front of bulldozer's blade. Excessive penetration of tracks into the surface was not noticed, nor was there any skidding during the full load of the blade.

Table 1 Komatsu D155AX characteristics

Gross power of engine	268 kW
Machine weight	395 kN
Blade type	straight (S-type)
Blade height	1,85 m
Blade width	4,06 m
Vertical blade curvature	$R = 1,58$ m ($c = 0,28$ m)

Measuring included volume of dragging prism in front of bulldozer's blade and the velocity of motion during blade filling, transporting and backwards return. The volume of dragging prism is determined using software for photogrammetric analysis from pairs of photographs. An empty blade was photographed first and then the blade load during two operating cycles. The volume of blade load that gravitationally lowers over the edge of the bench was gained by subtraction of volume of rock mass situated on the side, outside of the blade's reach (Fig. 4).

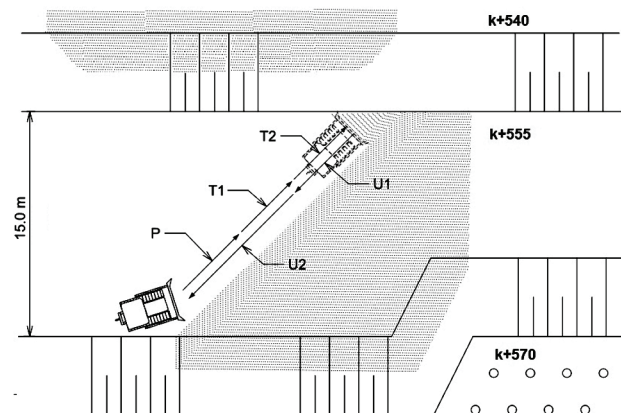

Figure 3 Bulldozer's operating cycle with measurement sections (P - blade filling; T1, T2 - transporting; U1, U2 - return)

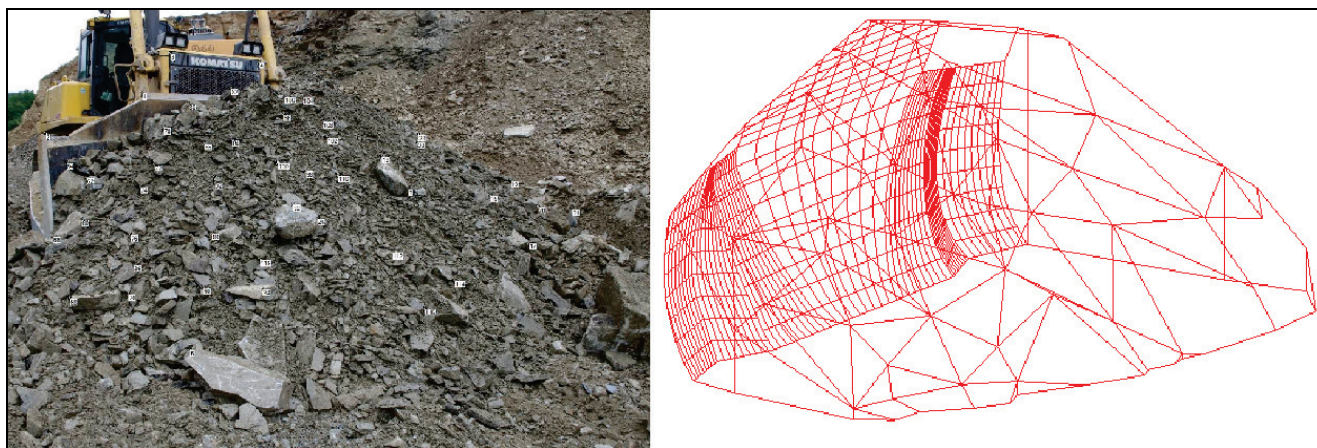

Figure 4 Volume of blade load, snapshot (left) and three-dimensional model (right)

Table 2 Summarized measuring results

Cycle	Speed on measuring section (m/s)					Direction change time (s)		Blade load volume (m ³)
	P (8 m)	T1 (8 m)	T2 (8 m)	U1 (8 m)	U2 (16 m)	Forwards	Return	
1	0,62	0,66	0,57	0,77	1,58	3-4	3-4	9,74
2	0,66	0,67	0,65	0,88	1,35			9,81
3	0,66	0,69	0,81	0,94	1,29			-
4	0,55	0,55	0,90	1,09	1,56			-
Average value	0,62	0,68		1,21		3-4		9,77

P – blade filling, T – transport, U – backwards return

Velocity of bulldozer was observed in several sections inside of every cycle; it was determined by measuring the passing time of front and rear axle next to the control points, and they were calculated on the basis of known wheelbase that amounts to 3,275 m. When moving forward, the trajectory is divided in three sections (Fig. 3) primarily to be able to differ between velocity of blade filling and velocity of transport, but also to achieve more representative average value since it was noticed that speed during transport varies to a lesser extent. It is assumed that speed during transport varies when resistance changes, which is caused by large fragments that are wedged in beneath the lower edge of blade.

Returning trajectory was divided in two sections because it was noticed that the bulldozer moves more slowly at a 10-meter distance from the edge of the bench because of the accumulated material and lying larger rock fragments, while it moves faster and uniformly on a clear section of the bench. Summarized data obtained by measuring, average value of motion velocity and volume of blade load are shown in Tab. 2.

Table 3 Comparison of bulldozer's motion speed

	Forward	Return
Computational rimpull (kN)	213,7 ÷ 257,6	11,1 ÷ 15,8
Speed according to theoretic formula (m/s)	0,83 ÷ 1,13	13,57 ÷ 19,59
Speed according to adjusted formula (m/s)	0,69 ÷ 0,85	5,19 ÷ 6,53
Speed according to rimpull diagram (m/s)	0,69 ÷ 0,81	3,15 ÷ 3,20
Average measured speed (m/s)	0,66	1,21

Comparison of blade load volumes according to given formulas and spans of parameters is shown in Fig.

5, while the calculated and measured velocities are compared in Tab. 3.

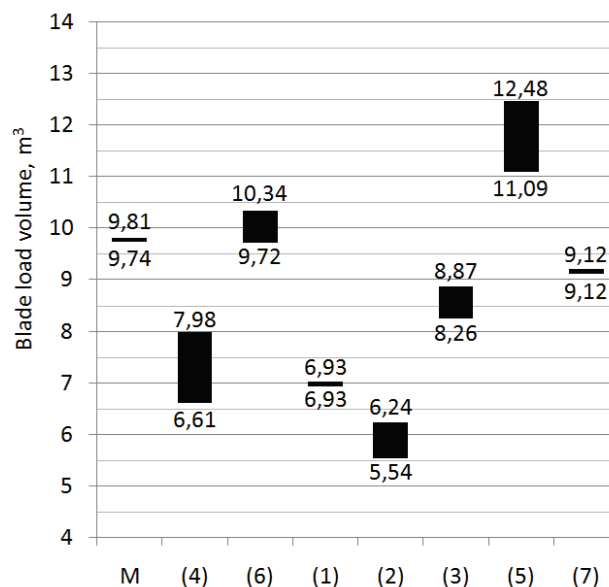

Figure 5 Comparison of blade load volume by different formulas (M – measured value, (1 ÷ 7) – formula reference)

4 Results analysis

Average deviation of computational from measured volume of blade load, calculated according to various authors, is shown in Fig. 6. Minor deviations have been noticed for three formulas. Deviation of volume in formula (3) amounts to 12 %, and with the inclusion of vertical blade curvature (6), it lowers to 3 %. Blade curvature has a significant impact on the volume of blade load and it should not be neglected in the calculation. Formula for straight blade according to the standard

SAEJ1265 (7) also gives relatively favourable results, with a 6 % deviation.

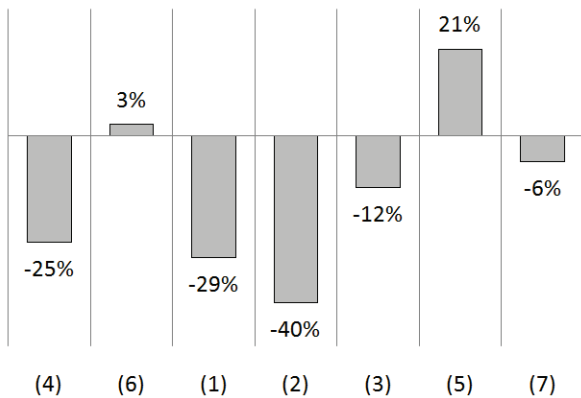

Figure 6 Mean deviations of blade load volume ((1 ÷ 7) - formula reference)

Bulldozer's motion speed is determined by a theoretical and adjusted formula, and also by manufacturer's rimpull diagram. Deviations from the measured values are shown in Fig. 7. The theoretical and adjusted formula results in an unrealistic computational return speed, that is, far greater from the practically possible maximum speed of bulldozer of approximately 3,5 m/s.

When moving forward (transporting), rimpull diagram and adjusted formula can yield realistic values of speed. However, difficulties arise from theoretical assessment of the necessary rimpull, that is, resistance to pushing the blade load. In this case, deviation amounts to less than 16 %.

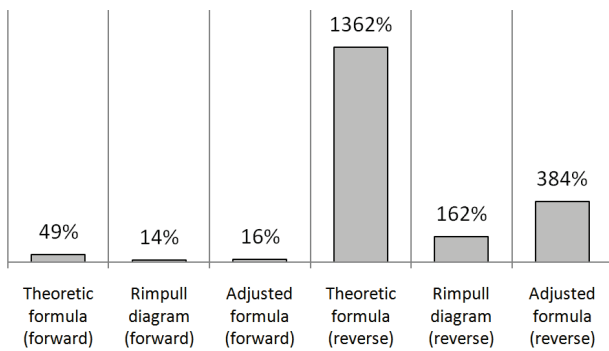

Figure 7 Mean deviations of bulldozer's speed

During return, the only resistance is the rolling resistance, which does not go over 50 kN, even with a specific rolling resistance of 0,12. Therefore, bulldozer can in theory almost gain maximum speed when returning, although the highest speed measured amounts to 1,58 m/s. It can be concluded that resistance is not the key influential factor during return. The short bulldozer's trajectory is imposed by visibility and remaining large rock fragments. Because of that, the operator, out of caution, does not accelerate the bulldozer to its possible limit. The computational return speed significantly deviates from the actual one that was measured (>160 %), and it is more reliable to determine it by experience or by measuring.

With constant bulldozer's trajectory length, determined from known geometrical elements of quarry, volume of blade load and bulldozer's speed have the greatest influence on the productivity of bulldozer's cycle.

Parametric analysis has been conducted by the variation of parameters around the average determined value ranging from ±30 % for two procedures of productivity assessment. The first procedure includes an independent assessment of the volume of blade load, and bulldozer's speed, with dependence of productivity on equations (12) and (13). Productivity change in relation to parameter change is shown in Fig. 8. It is noticeable that with the independent assessment of volume of blade load and speed of bulldozer, the productivity can significantly deviate from the actual one. In Fig. 8 is obvious the ratio of productivity change to volume of blade load change -1, to the change of transport speed 0,51 ÷ 0,66 and to the return speed 0,26 ÷ 0,4.

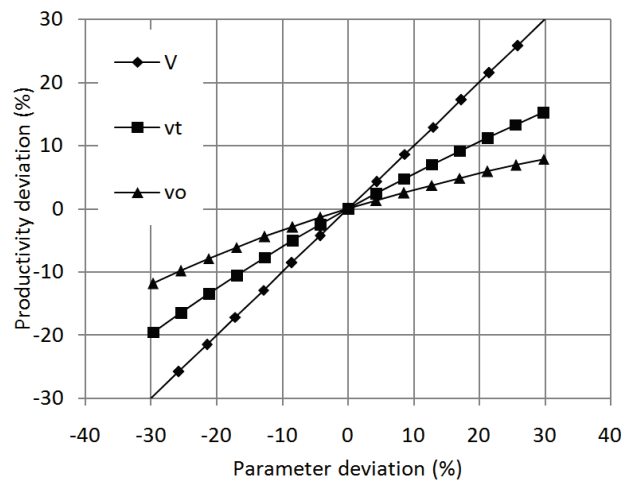

Figure 8 Influence of the independent assessment of volume of blade load and bulldozer's speed on the cycle productivity

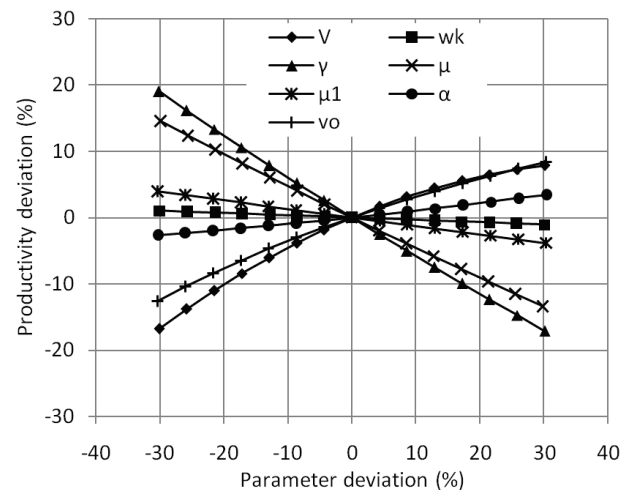

Figure 9 Parametric analysis of the influence on cycle productivity

The other procedure of productivity assessment takes into account the dependence of rimpull according to formula (9), bulldozer's speed during transport according to formula (11), and productivity of bulldozer's cycle according to formulas (12, 13). Bulldozer's productivity and transporting speed are computationally connected with the volume of blade load, while the return speed is

evaluated by experience. The influence of certain parameters is shown in Fig. 9. The influence of volume of blade load is noticeably reduced because of the interdependence with transporting speed; in other words, the increase of volume causes speed reduction and vice versa. The influence is nonlinear, with productivity to blade volume ratio of $0,26 \div 0,56$. However, other parameters need to be considered, especially bulk density of material that changes the productivity with ratio 0,6 and friction coefficient on the ground with ratio 0,47. Cutting angle and friction coefficient on bulldozer's blade in relation to other parameters will not have a major influence on productivity assessment. Return speed remains an independent parameter and retains an influence with ratio $0,26 \div 0,4$.

5 Discussion and conclusion

Based on material's angle of repose and dimensions of bulldozer's blade, it is relatively possible to reliably determine volume of blade load during gravitational transport of overburden and mineral raw material. The proposed formula (6) which takes into account vertical curvature of the blade has the average deviation of just 3 % from the measured value and proved itself correct.

Assuming the resistance to pushing blade load has been correctly determined, rimpull diagram and adjusted formula give good results during transport because of the prevailing resistance influence on the speed of bulldozer's motion. The adjusted formula gives the approximate result as the diagram because it was created by the statistical analysis of the diagram. According to the parametric analysis, the greatest influence on resistance to pushing blade load, and ultimately transport speed, have the volume of blade load, bulk material density and friction coefficient on the ground. Bulk density is the most commonly known value during exploitation which can reliably be used in the calculation. On the other hand, friction coefficient on the ground is difficult to measure and needs to be estimated carefully.

During bulldozer's return, resistance to movement does not have the prevailing influence, which is why the computational determining of speed introduces a great error in the productivity assessment. It is more accurate to estimate the speed of return by experience.

Bulldozers without load can move at a speed of 3,5 m/s, although in a typical dozing technique the speed of return amounts to $1,4 \div 1,9$ m/s [14]. Due to the specific work conditions on the bench of the quarry, the speed is even lower. The measured speed of return is ranging between 0,77 and 1,58 m/s, and these values represent a minimal and maximal measured speed. The average speed on the clear part of the bench amounts to 1,43 m/s, and near the crest, where is the accumulated material, amounts to 0,9 m/s. Assuming that similar conditions exist during gravitational transport on other quarries of crushed stone, the speed of return can be estimated inside of this span.

According to measured speed and volume of blade load, the actual productivity of bulldozer's cycle amounts to 535 m³/h. Computationally determined bulldozer's productivity ranges from 477 m³/h to 642 m³/h, with determining the volume of blade load according to the

equation (6) and transport speed according to the equation (11), along with the specified parameter spans and speed of return (0,9 to 1,43 m/s). Deviation of computationally determined bulldozer's productivity with regard to the measured one ranges between -10,9 % and +20 %.

6 References

- [1] Shmulevich, I.; Asaf, Z.; Rubinstein, D. Interaction between soil and a wide cutting blade using the discrete element method. // *Soil & Tillage Research*. 97, (2007), pp. 37-50.
- [2] Shmulevich, I. State of the art modeling of soil-tillage interaction using discrete element method. // *Soil & Tillage Research*. 111, (2010), pp. 41-53.
- [3] Tsuji, T.; Nakagawa, Y.; Matsumoto, N.; Kadono, Y.; Takayama T.; Tanaka, T. 3-D DEM simulation of cohesive soil-pushing behavior by bulldozer blade. // *Journal of Terramechanics*. 49, (2012), pp. 37-47.
- [4] Mootaz Abo-Elnor; Hamilton, R.; Boyle, J.T. Simulation of soil-blade interaction for sandy soil using advanced 3D finite element analysis. // *Soil & Tillage Research*. 75, (2004), pp. 61-73.
- [5] Kaiming Xia. A framework for earthmoving blade/soil model development. // *Journal of Terramechanics*. 45, (2008), pp. 147-165.
- [6] Slunjski, E. *Strojevi u građevinarstvu*. Hrvatsko društvo građevinskih inženjera, Zagreb, 1995.
- [7] Marković, V. *Građevinske mašine za zemljane radove*. Naučna knjiga, Beograd, 1975.
- [8] Mikulić, D. *Građevinski strojevi: konstrukcija, proračun i uporaba*. Zagreb, 1998.
- [9] Simonović, M. *Tehnika površinskog otkopavanja*. Serija A. Rudarski institut, Beograd, 1967.
- [10] *Le macchine per i lavori stradali*. Touring club Italiano, Milano, 1962.
- [11] Linarić, Z. *Leksikon osnovne građevinske mehanizacije*. Business media Croatia, Zagreb, 2007.
- [12] Bulldozer blades capacities. The society of automotive engineers. URL: http://www.cwsindustries.com/images/pdf/techdata/rating_dozer_blades.pdf
- [13] Trbojević, B. *Građevinske mašine*. Građevinska knjiga, Beograd, 1958.
- [14] *Komatsu performance handbook*. Edition 27. Komatsu Inc., 2006.
- [15] *Caterpillar performance handbook*. Edition 29. Caterpillar Inc., 1998.

Authors' addresses

Mario Klanfar, dipl. ing.

University of Zagreb
Faculty of mining, geology and petroleum engineering
Pierottijeva 6, 10000 Zagreb, Croatia
E-mail: mario.klanfar@rgn.hr

Trpimir Kujundžić, prof. dr. sc., dipl. ing.

University of Zagreb
Faculty of mining, geology and petroleum engineering
Pierottijeva 6, 10000 Zagreb, Croatia
E-mail: trpimir.kujundzic@rgn.hr

Darko Vrkljan, prof. dr. sc., dipl. ing.

University of Zagreb
Faculty of mining, geology and petroleum engineering
Pierottijeva 6, 10000 Zagreb, Croatia
E-mail: darko.vrkljan@rgn.hr